

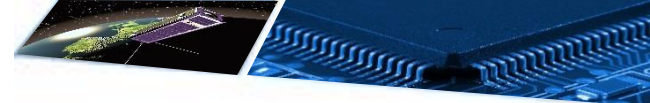

Universidad
de Alcalá



Space Research Group (SRG-UAH) OBDH



Jornada Ciencia e Industria

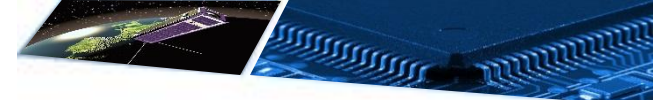

OBDH

OBSW

OBCDH

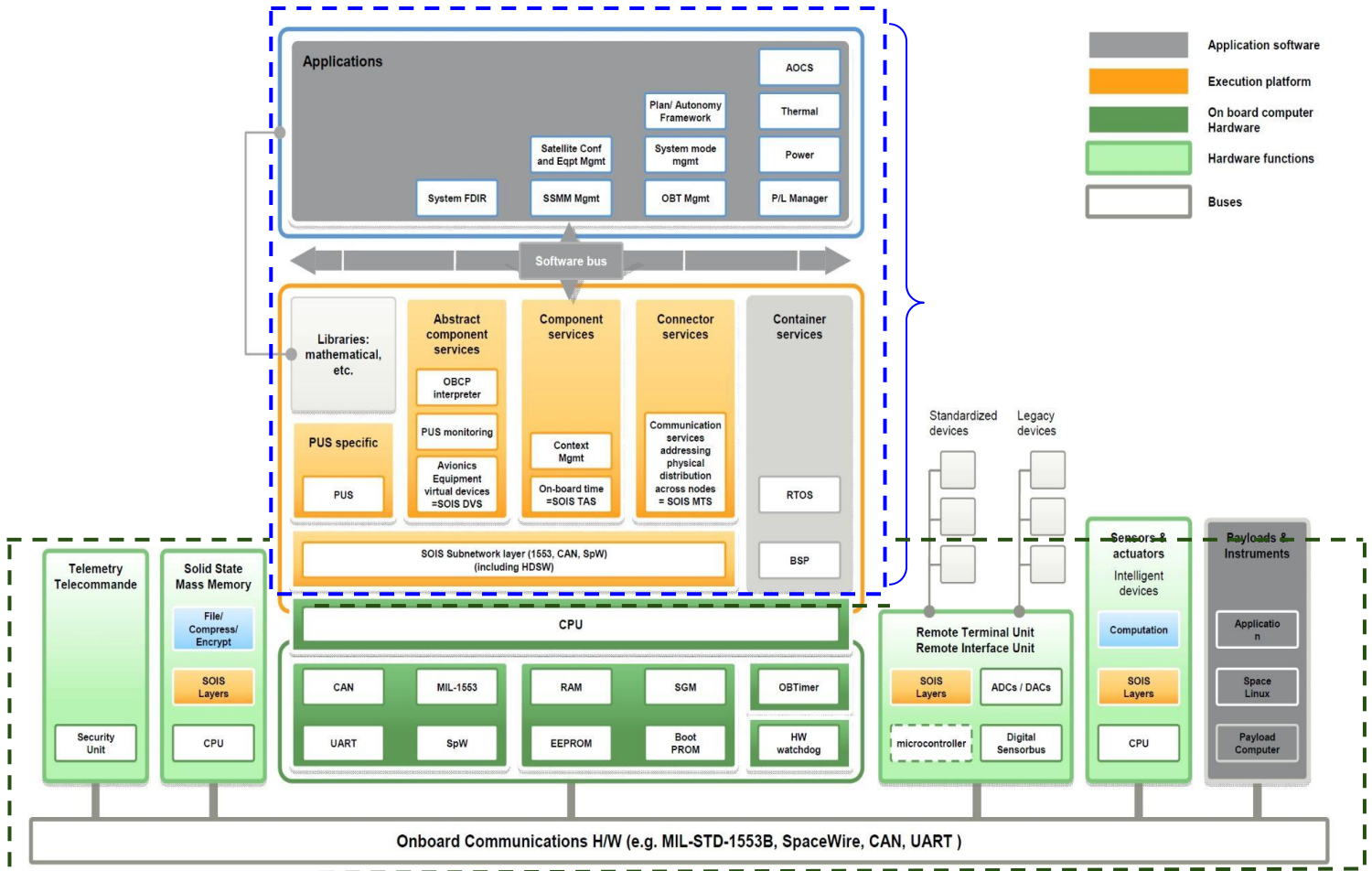

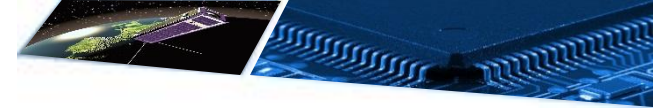

OBDH

OBSW



Nanosat 01
2004

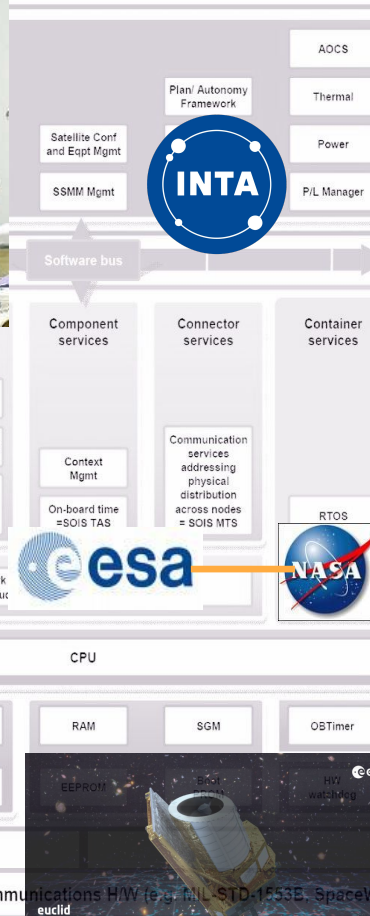

Nanosat 1B
2009

OBCDH

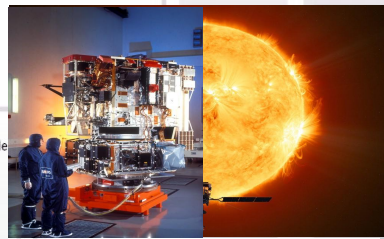

SOHO 1995



Solar Orbiter

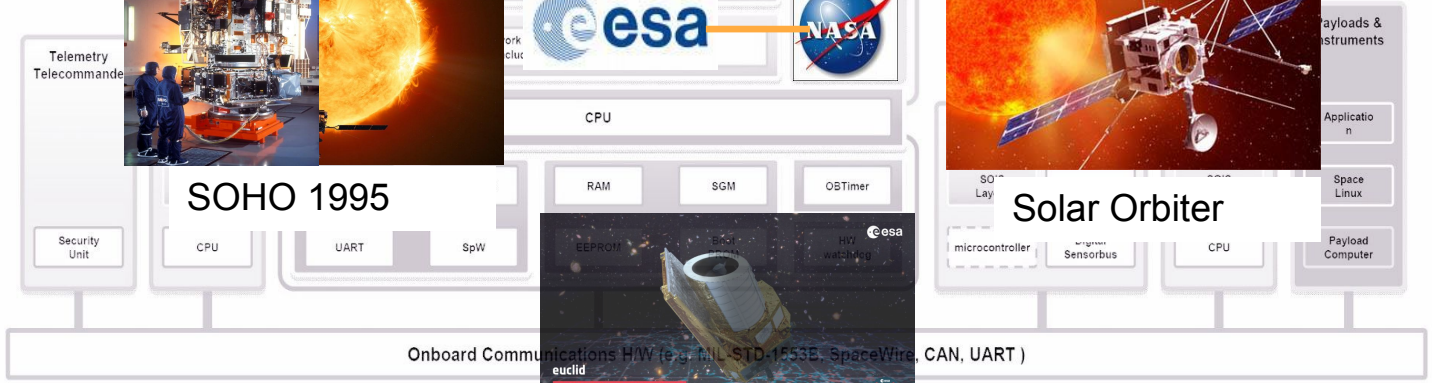

Euclid 2023



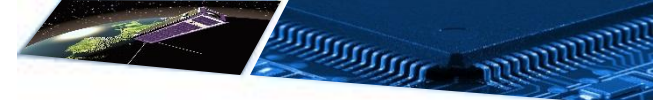

OBCDH

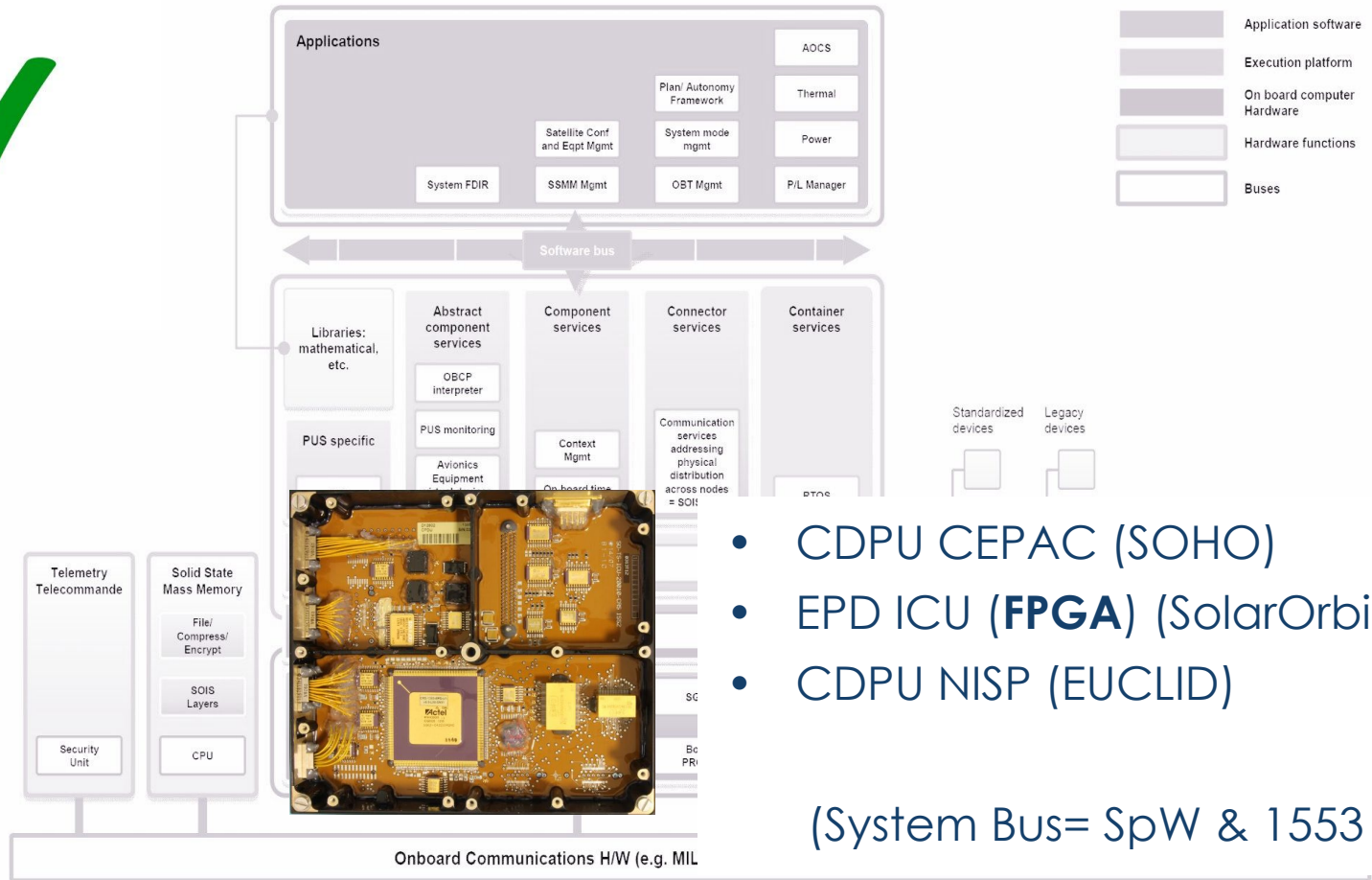

- CDPU CEPAC (SOHO)
- EPD ICU (**FPGA**) (SolarOrbiter)
- CDPU NISP (EUCLID)

(System Bus= SpW & 1553)



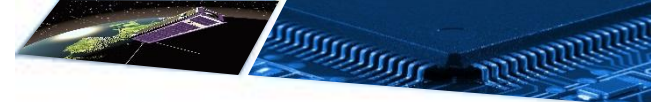

OBSW

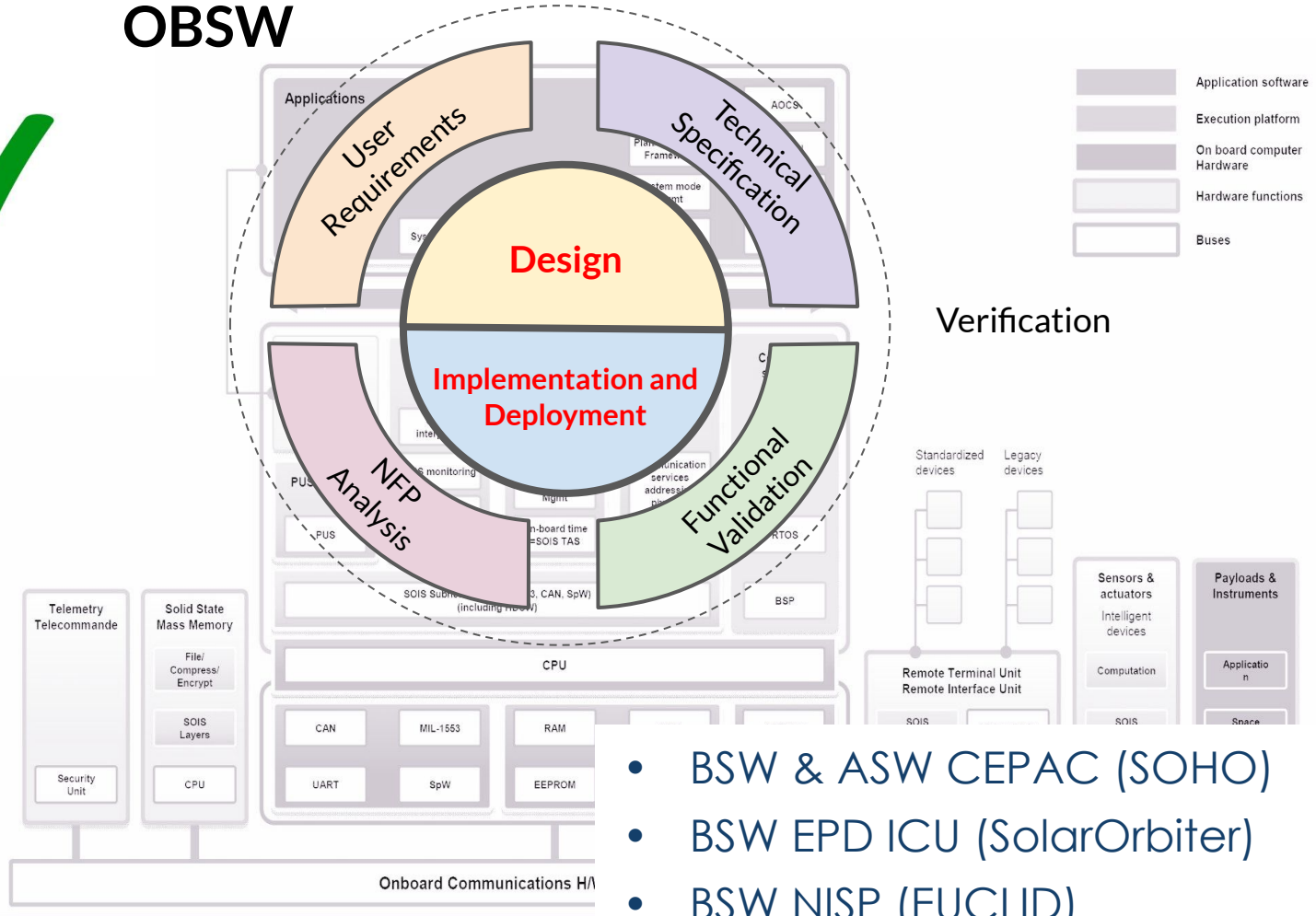

- BSW & ASW CEPAC (SOHO)
- BSW EPD ICU (SolarOrbiter)
- BSW NISP (EUCLID)



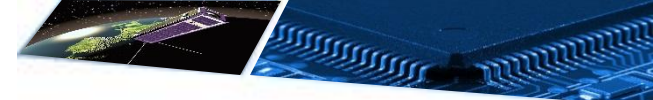

OBSW

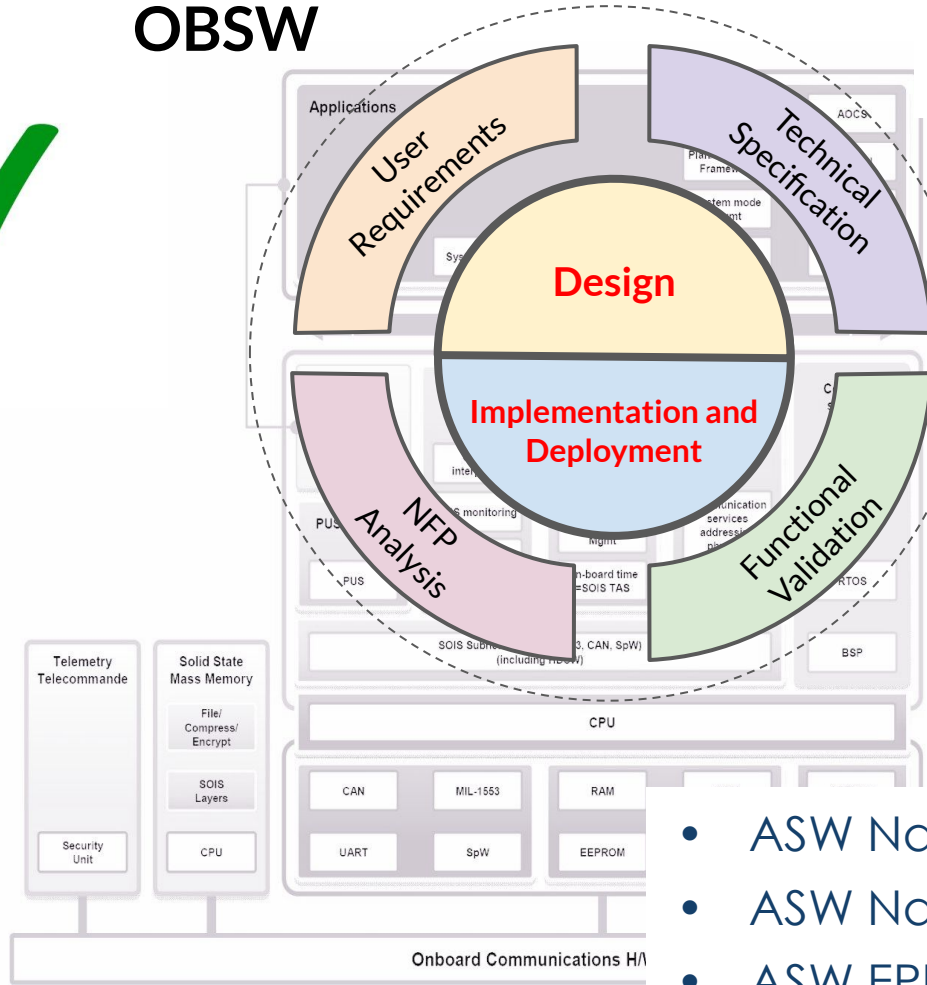

CBSE (Automatic Code Generation)

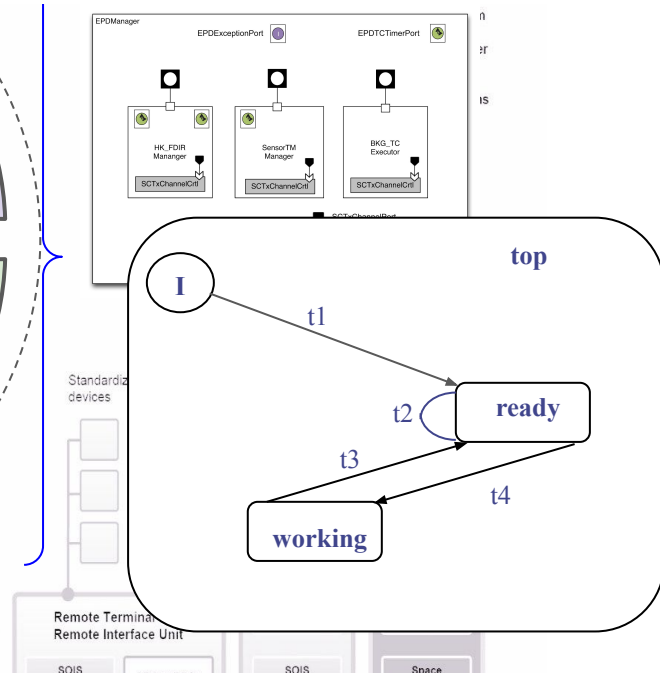

- ASW Nanosat-01
- ASW Nanosat-1B
- ASW EPD ICU (SolarOrbiter)



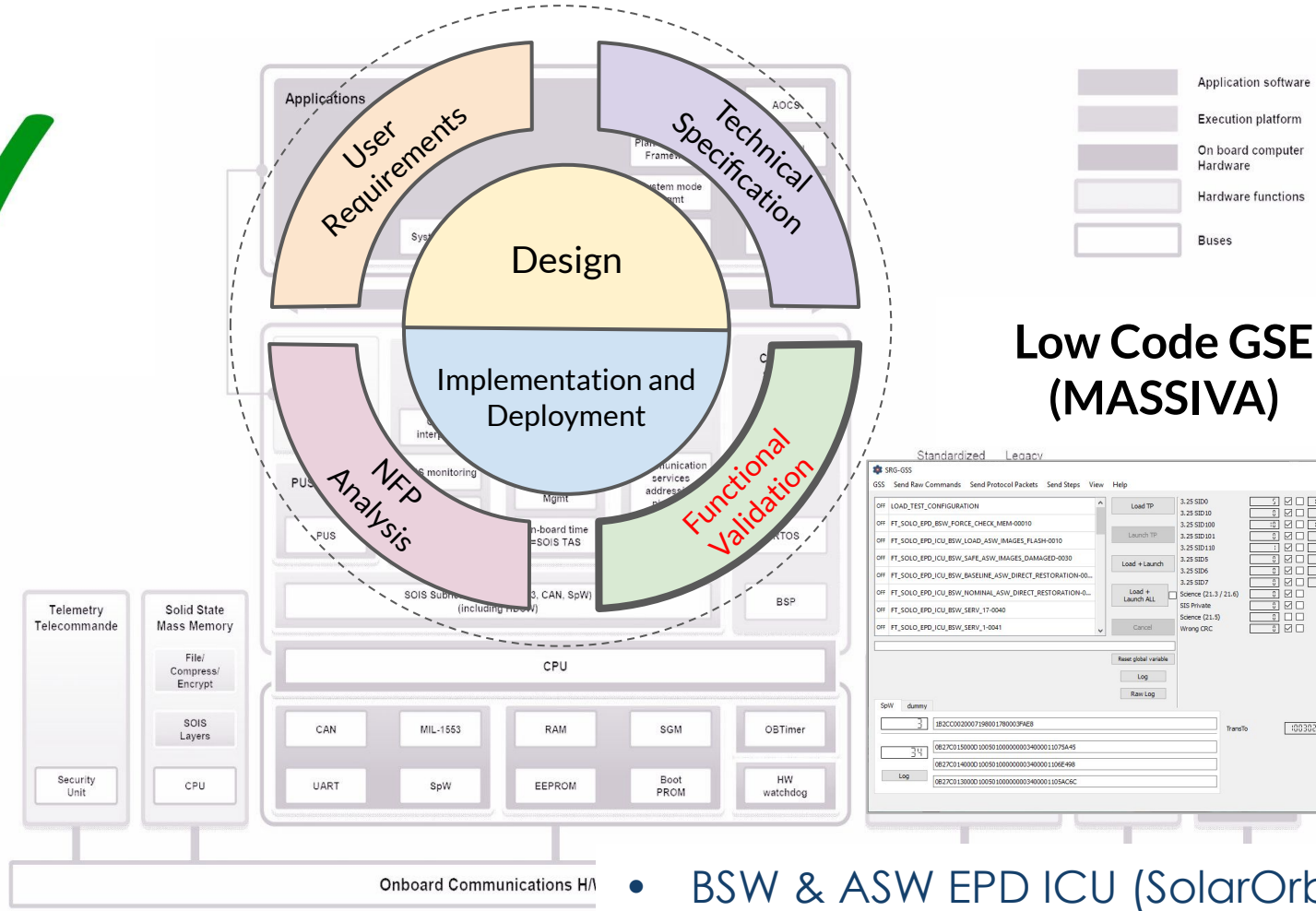
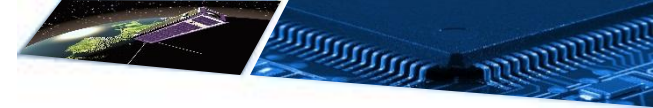

Low Code GSE (MASSIVA)

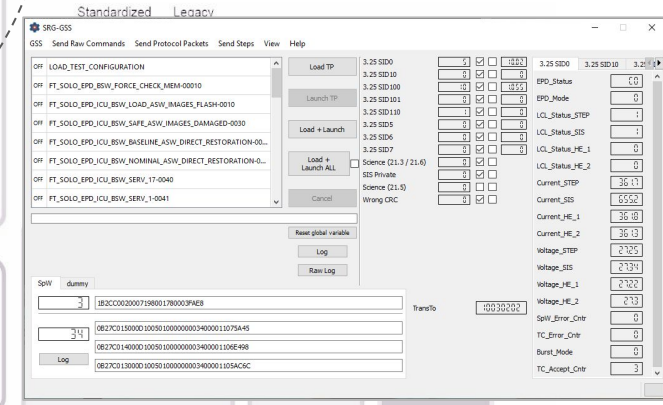

- BSW & ASW EPD ICU (SolarOrbiter)



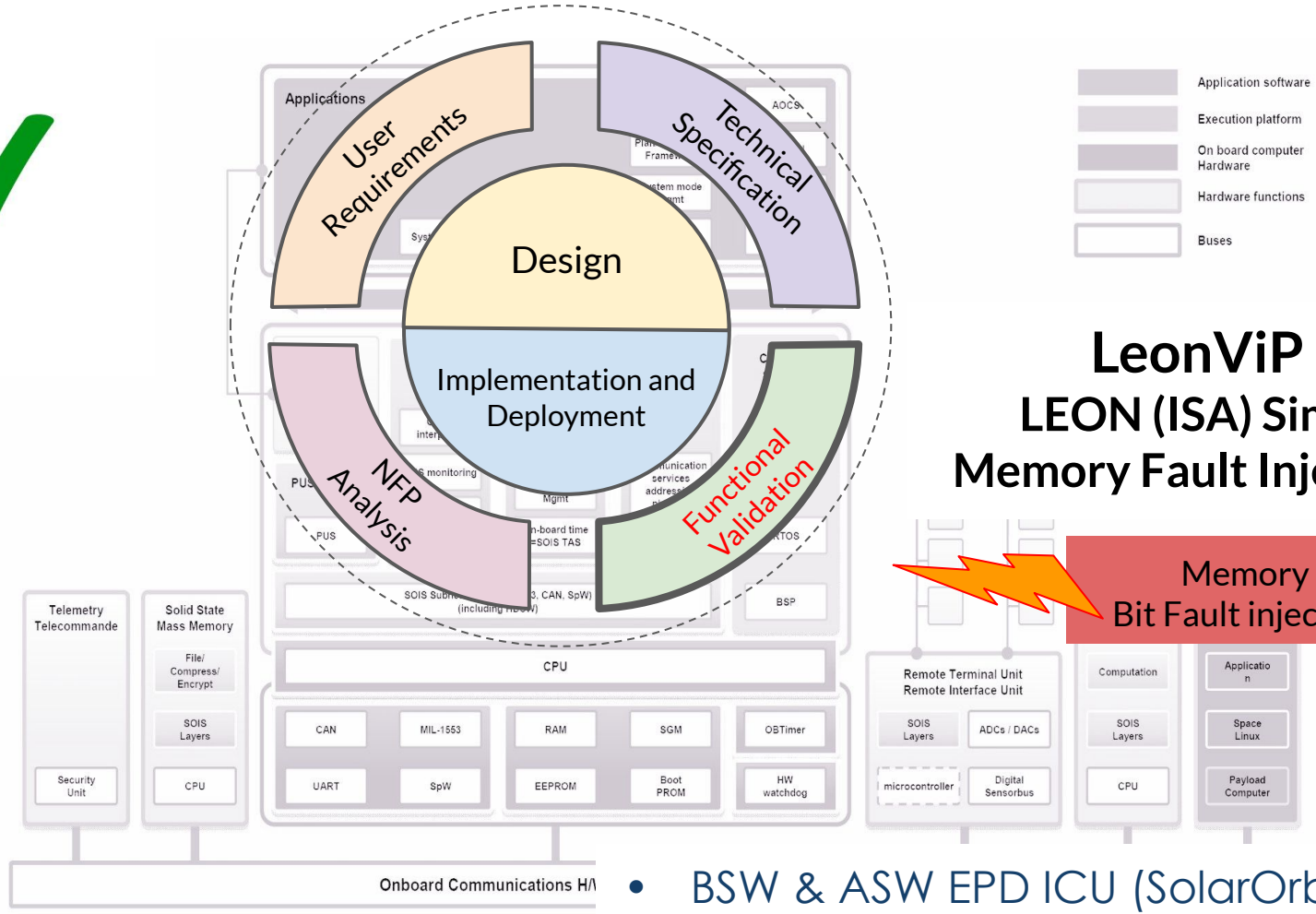
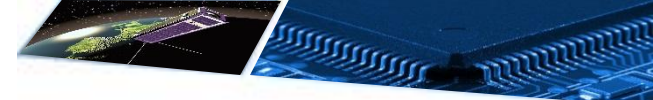

LeonViP LEON (ISA) Sim + Memory Fault Injection

- BSW & ASW EPD ICU (SolarOrbiter)



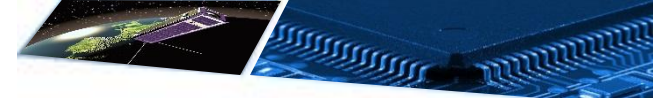

In progress

- LEON3 Virtualization extensions (**GMV-Air HyperVisor**)
- MMU **Stuck bit Fault Tolerant** (FPGA-IPcore)
- RISC-V **VHDL**
 - Performance Monitor Unit
 - Non-Intrusive Trace Pipeline (**patented**)

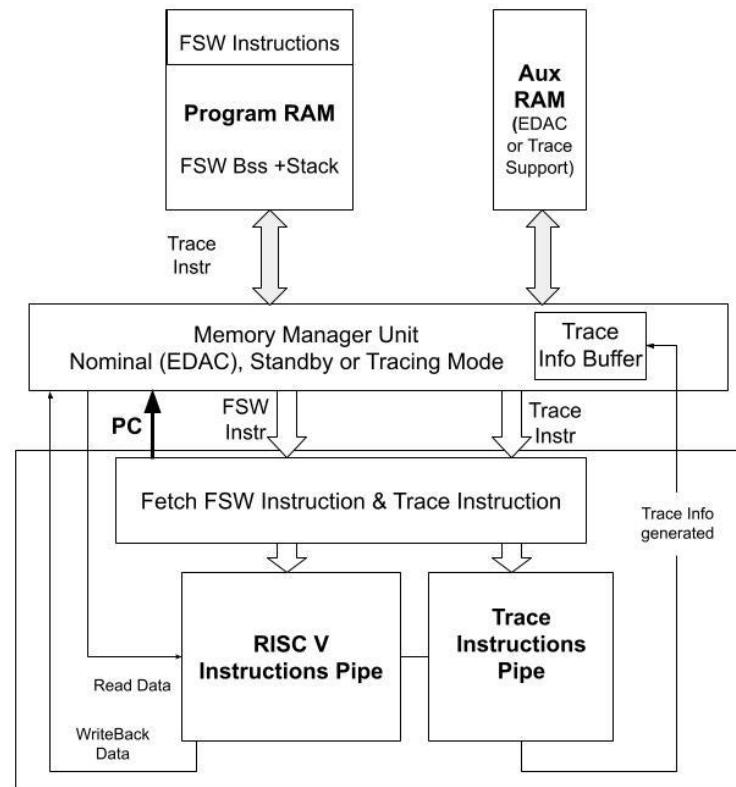



In progress



Termina (Domain-Specific Programming Language)



Schedulability Model

annotate

Termina source code

transpile

C

Termina runtime

RTOS

MISRA-C 2012
C11 Language
version

Load program binary

WCET trace config via PUS TC&TM



TC
TM

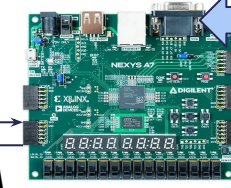

RISC-V +
Non-Intrusive Trace



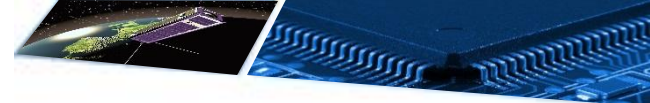

DIGITAL BEAM FORMING (Optimized with IA)



In progress

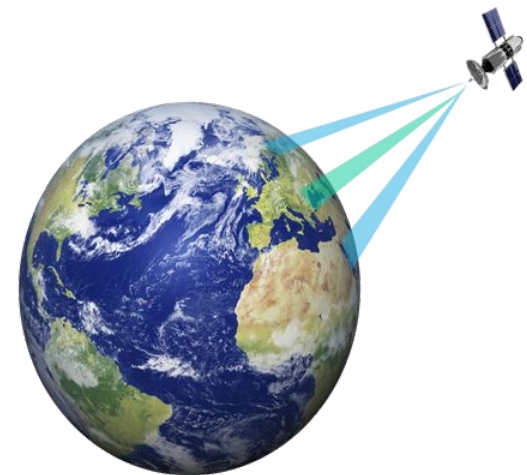
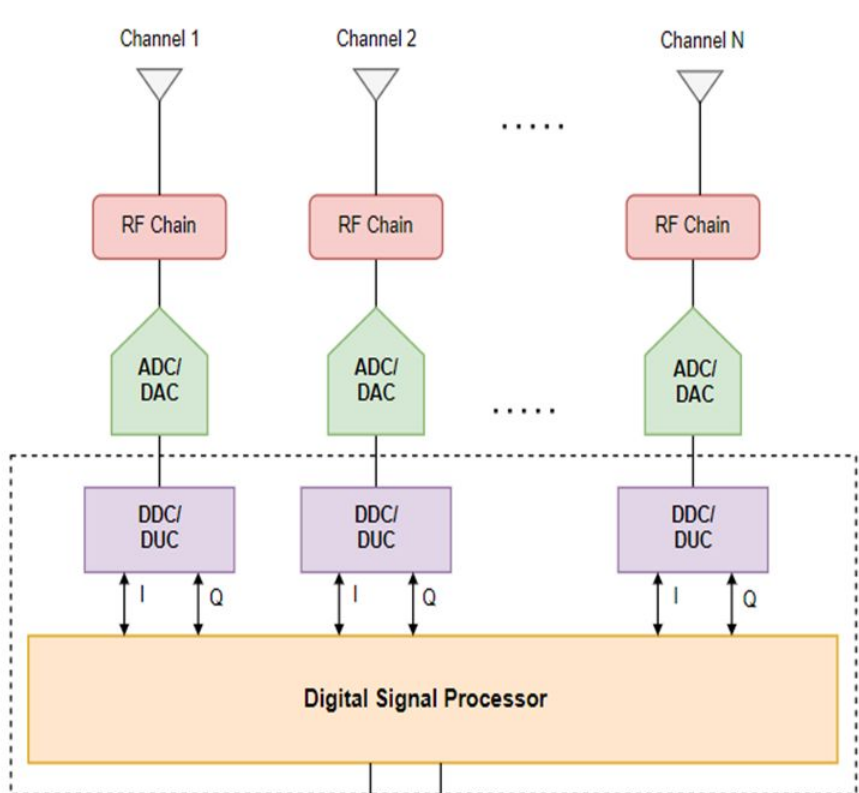

- VHDL (Kintex UltraScale FPGA)

